

dyson pure hot+cool link

Setting up Dyson Link app

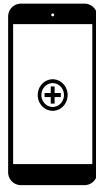

1. Download the Dyson Link app, available on iOS and Android.
2. Select 'Add a Product' from within the app and follow the on screen instructions.
3. Input the above information when requested to do so.

OPERATING MANUAL

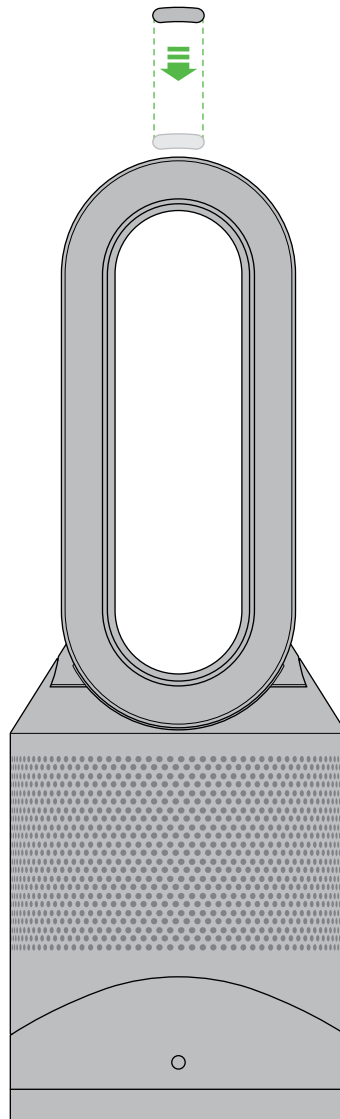

**REGISTER YOUR FREE
2 YEAR GUARANTEE
TODAY**



Thank you for choosing to buy a Dyson appliance

After registering your free 2 year guarantee, your Dyson appliance will be covered for parts and labour (excluding filters) for 2 years from the date of purchase, subject to the terms of the guarantee. If you have any questions about your Dyson appliance, call the Dyson Helpline with your serial number and details of where/when you bought the appliance. Most questions can be solved over the phone by one of our trained Dyson Helpline staff.

Your serial number can be found on your rating plate which is on the base of the appliance.

Visit www.dyson.co.uk/support (UK) or www.dyson.ie/support (ROI) for online help, support videos, general tips and useful information about Dyson.

Note your serial number for future reference.



This illustration is for example purposes only.

IMPORTANT SAFETY INSTRUCTIONS

BEFORE USING THIS APPLIANCE READ ALL INSTRUCTIONS AND CAUTIONARY MARKINGS IN THIS MANUAL AND ON THE APPLIANCE

When using an electrical appliance, basic precautions should always be followed, including the following:

WARNING

THE APPLIANCE AND THE REMOTE CONTROL BOTH CONTAIN MAGNETS.

1. Pacemakers and defibrillators may be affected by strong magnetic fields. If you or someone in your household has a pacemaker or defibrillator, avoid placing the remote control in a pocket or near to the appliance.
2. Credit cards and electronic storage media may also be affected by magnets and should be kept away from the remote control and the top of the appliance.

WARNING

These warnings apply to the appliance, and also where applicable, to all tools, accessories, chargers or mains adaptors.

TO REDUCE THE RISK OF FIRE, ELECTRIC SHOCK, OR INJURY:

1. When used in heating mode the appliance is hot when in use and for a short period after use. To avoid burns, do not let bare skin touch hot surfaces. When moving the appliance hold it by the base, not the air loop amplifier.
2. Keep combustible materials, such as furniture, pillows, bedding, papers, clothes and curtains, at least 0.9m (3 feet) from the front of the appliance and keep them away from the sides and rear when the appliance is plugged in.
3. Use only as described in this Dyson Operating Manual. Do not carry out any maintenance other than that shown in this manual, or advised by the Dyson Helpline. Any other use not recommended by the manufacturer may cause fire, electric shock, or injury to persons.
4. Ensure appliance is fully assembled in line with the instructions before use. Do not dismantle the appliance or use without the loop amplifier fitted.
5. Do not allow to be used as a toy. Close attention is necessary when used by or near children. Children of less than 3 years should be kept away unless continuously supervised. Children should be supervised to ensure that they do not play with the appliance and remote control.
6. Children aged from 3 years and less than 8 years shall only switch on/off the appliance provided that it has been placed or installed in its intended normal operating position and they have been given supervision or instruction concerning use of the appliance in a safe way and understand the hazards involved. Children aged from 3 years and less than 8 years shall not plug in, regulate and clean the appliance or perform user maintenance. CAUTION – Some parts of this product can become very hot and cause burns. Particular attention has to be given where children and vulnerable people are present.
7. This Dyson appliance can be used by children aged from 8 years and above and persons with reduced physical, sensory or reasoning capabilities, or lack of experience and knowledge, only if they have been given supervision or instruction by a responsible person concerning use of the appliance in a safe way and understand the hazards involved. Cleaning and user maintenance should not be performed by children without supervision.
8. Suitable for dry locations ONLY. Do not use outdoors or on wet surfaces. Do not use in bathrooms, laundry areas or similar indoor locations. Never locate the appliance where it may fall into a bath or other water container. Do not use or store where it may get wet or in the immediate surroundings of a bath, a shower, or a swimming pool.
9. This appliance has hot parts inside. Do not use it in areas where petrol, paint, or flammable liquids are used or stored or where their vapours are present. Do not use in conjunction with or directly next to an air freshener or similar products.
10. Do not locate directly below a mains electricity supply socket.
11. Always plug directly into a wall socket. Never use with an extension cable as overloading may result in the cable overheating and catching fire.
12. Do not handle any part of the plug or appliance with wet hands.

13. Do not use with a damaged cable or plug. If the supply cable is damaged it must be replaced by Dyson, its service agent or similarly qualified person in order to avoid a hazard.
14. Do not unplug by pulling on the cable. To unplug, grasp the plug, not the cable.
15. Do not stretch the cable or place the cable under strain. Keep cable away from heated surfaces.
16. Do not route the cable under furniture or appliances. Do not cover cable with throw rugs, runners or similar coverings. Arrange cable away from traffic area and where it will not be tripped over.
17. To prevent a possible fire, do not use with any opening or exhaust blocked, and keep free of dust, lint, hair, and anything that may reduce airflow. Do not put any object into the inlet grill or the exhaust opening as this may cause an electric shock or fire, or damage the appliance.
18. Do not use on soft surfaces, such as a bed, where openings may become blocked.
19. In order to avoid overheating and fire hazard, do not cover the appliance.
20. For the best performance, place on the floor, in the corner of the room, at least 1m from any wall and facing into the centre of the room.
21. Turn off all controls before unplugging. Unplug before connecting any tool or accessory.
22. Do not use any cleaning agents or lubricants on this appliance. Unplug before cleaning or carrying out any maintenance.
23. If there is a loose fit between the plug and the socket or the plug becomes very hot, the socket may need to be replaced. Check with a qualified electrician to replace the socket.
24. **WARNING: Chemical Burn and Choking Hazard.** Keep batteries away from children. This product contains a lithium button/coin cell battery. If a new or used lithium button/coin cell battery is swallowed or enters the body, it can cause severe internal burns and can lead to death in as little as 2 hours. Always completely secure the battery compartment. If the battery compartment does not close securely, stop using the product, remove the batteries, and keep it away from children. If you think batteries might have been swallowed or placed inside any part of the body, seek immediate medical attention.
25. If the appliance is not working as it should, has received a sharp blow, has been dropped, damaged, left outdoors, or dropped into water, do not use and contact the Dyson Helpline.
26. Contact the Dyson Helpline when service or repair is required. Do not disassemble the appliance as incorrect reassembly may result in an electric shock or fire.
27. Do not put any object into openings or the inlet grille. Do not use with any opening blocked; keep free of dust, lint, hair, and anything that may reduce airflow.
28. Always carry the appliance by the base, do not carry it by the loop amplifier.
29. To avoid a tripping hazard wind the cable when not in use.
30. Do not use near furnaces, fireplaces, stoves or other high temperature heat sources.
31. Do not use in conjunction with or directly next to an air freshener or similar products. Do not spray or apply perfumes directly on or near the filter. Keep essential oils and chemicals away from the appliance.
32. The appliance should not be forcefully turned or oscillated, under any circumstances. This will cause damage to the oscillation mechanism.
33. When removing or replacing the filter, take care to keep your fingers clear.

IMPORTANT SAFETY FEATURES

For your safety this appliance is fitted with automatic cut-out switches that operate if it tips over or overheats. If the switches operate, unplug the appliance and allow it to cool. Before restarting, check and clear any blockages and ensure the appliance is on a solid level surface.

READ AND SAVE THESE INSTRUCTIONS

THIS DYSON APPLIANCE IS INTENDED FOR HOUSEHOLD USE ONLY

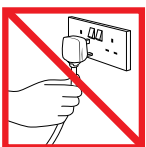

Do not pull on the cable.



In order to avoid overheating and fire hazard, do not cover the appliance.

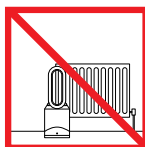

Do not store near heat sources.



Do not carry by the air loop amplifier. The air loop amplifier is not a handle.



Do not use near naked flames.



Do not spray scented products such as air freshener or perfume near the filter or the appliance.

Setting up Dyson Link app

The appliance can be enhanced when connected to the Dyson Link app on your smart device.



Download the Dyson Link app, available on iOS and Android.

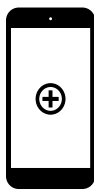

Select 'Add a Product' from within the app and follow the on screen instructions.

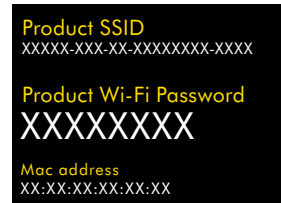

In order to connect the appliance, you will need the information on the front on this manual.

Display icons



Flashing green = Wi-Fi is ready to connect to your Dyson Link app



Flashing white = Wi-Fi connecting



Solid white = Wi-Fi connected

Off = Wi-Fi disabled



Solid white = cleaning/ air quality target has not been met



Solid green = clean/air quality target has been met

Off = appliance is not in auto cleaning mode



Solid red = appliance is heating



Solid white = appliance has reached target temperature



Solid white = appliance is in night mode

Off = appliance is not in night mode

Remote control

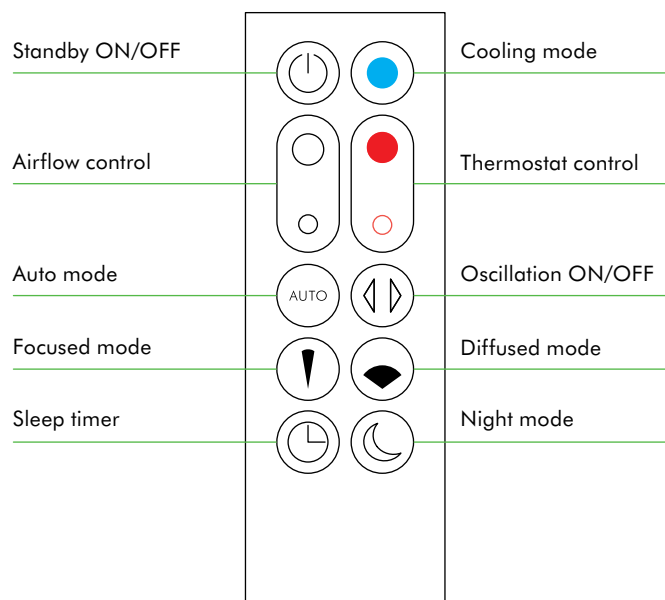

The Dyson Link app can also be used to control your appliance.

Remote control docks magnetically.
Attach the remote control to the top of the appliance with the buttons facing down.

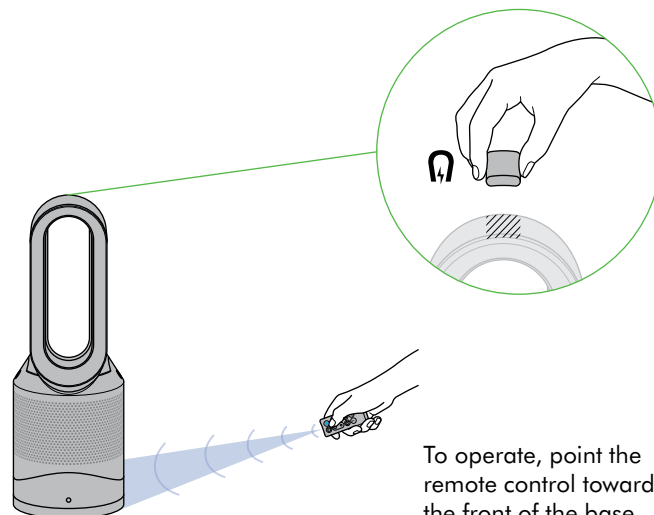

Appliance is in cooling mode

Press the blue cooling mode button to enter cooling mode. The power button light will change from red to blue to indicate that you have entered cooling mode.

To adjust the airflow speed use the airflow control button or use auto mode for automatic control.

On first use, the appliance will default to a temperature 3°C higher than the detected room temperature. Thereafter, the appliance will remember the last target temperature set.



Appliance is in heating mode

Press the red thermostat control button until the digital display shows the target room temperature. The power button light will change from blue to red to indicate that you have entered heating mode. The heating symbol will be red while heating and will change to white when the target room temperature has been reached. Once the target room temperature has been reached, the appliance will stop heating the air. If the room temperature falls below the target temperature, the appliance will start to heat again. The red circle surrounding the power button remains on when the product is in heater mode. To adjust the airflow speed use the airflow control button or use auto mode for automatic control.

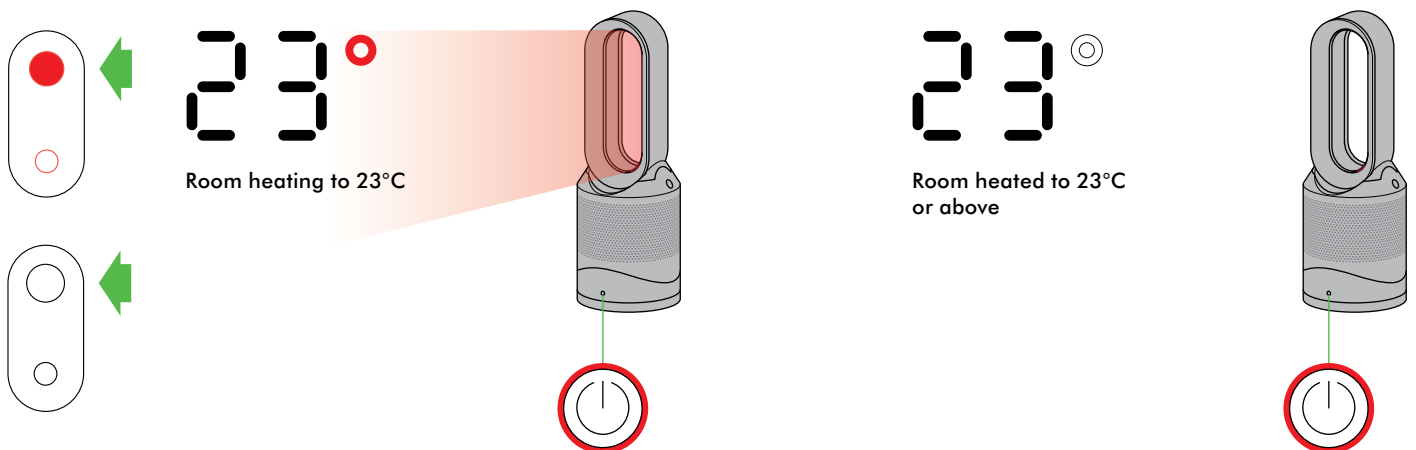

Each time the heating mode is selected, it conducts a short calibration cycle. Airflow will be automatically controlled during this cycle. Once the calibration cycle is complete, it will revert to the selected airflow speed.

Auto mode



Selecting auto mode adjusts the airflow according to the air quality in the room.

When auto mode is enabled (indicated by an A symbol in the bottom left corner of the display), the on-board sensors will intelligently adjust the speed of the appliance according to the air quality.

Appliance is in auto cooling mode

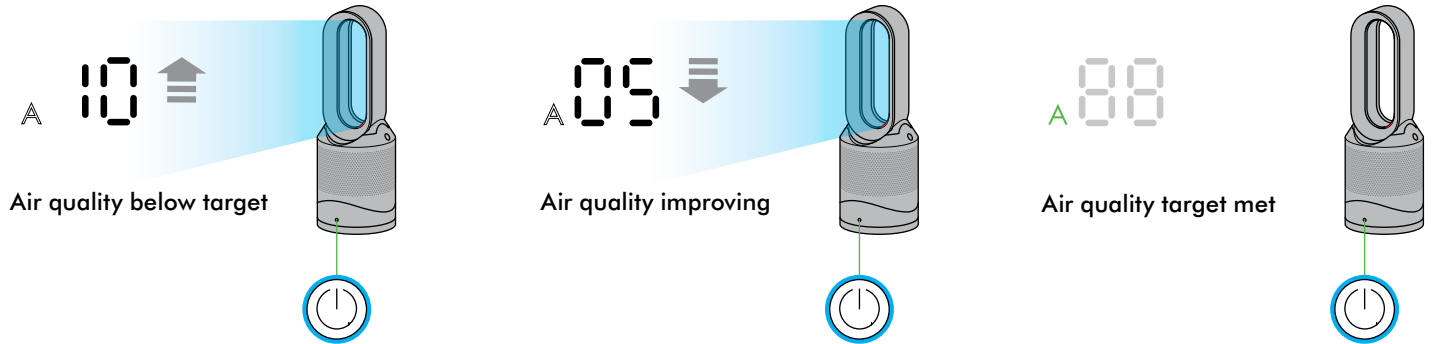

If the air is clean the A symbol will turn green and the numerical display will switch off. If the air quality worsens the A symbol will turn white and the appliance will automatically restart cleaning the room. While cleaning, the numerical display will show the airflow speed.

Appliance is in auto heating mode

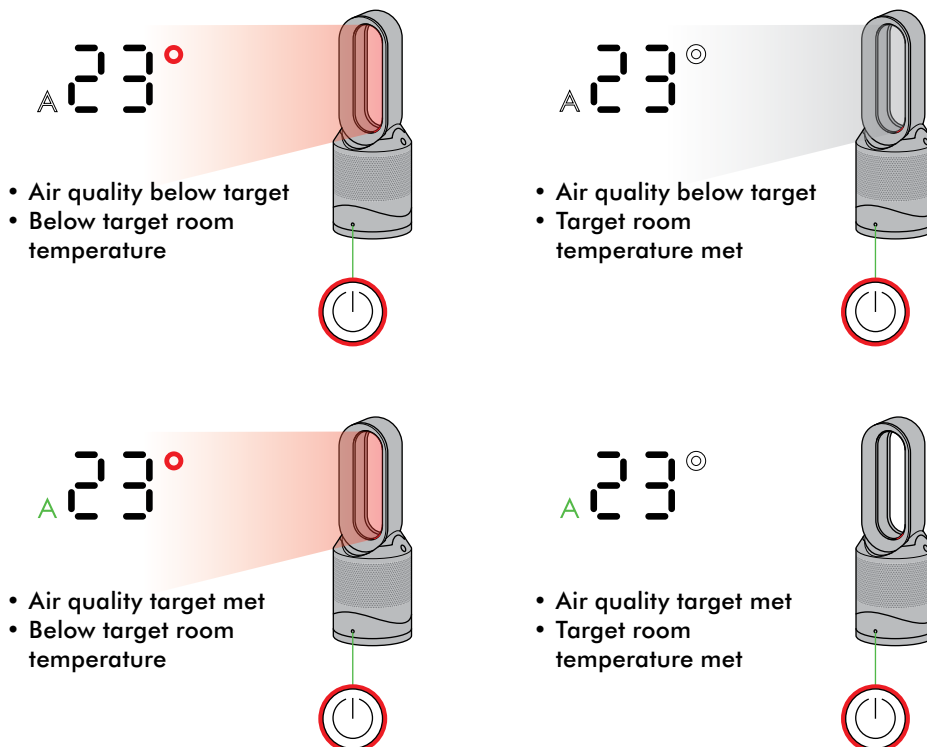

When auto mode is used while in heating mode, the appliance is both purifying and heating the air. The appliance will display the target room temperature, not the fan airflow. Once the target room temperature has been reached, the appliance will stop heating the air. If the air quality target has not been met, the fan will continue to run in order to keep purifying the air. If the room temperature falls below the target temperature, the appliance will start to heat again.



For additional control the Dyson Link app can be used to further adjust the sensitivity of the appliance.

A period of 6 days is required after the machine is first used for the sensor to calibrate. During this period the machine may be more sensitive to VOCs (such as odours) than normal.

Night mode



The night mode will dim the display and run quietly, making it ideal for use while sleeping.

When night mode is enabled (indicated by an illuminated half moon symbol in the bottom right corner of the display), the display will dim and after 5 seconds will fade to off. The half moon symbol remains illuminated.



If the appliance is not in auto mode, the airflow speed will reduce to level 4. When night mode is activated, if it is already below level 4, it will remain the same. This can be manually changed if desired. The display will illuminate briefly, then fade as before. If in auto mode the airflow speed will be reduced automatically.

Oscillation



Airflow speed control

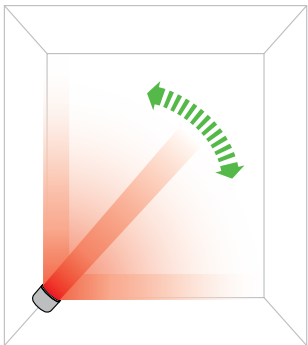
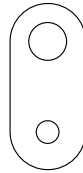

Oscillation control
To start the appliance oscillating, press the oscillation control button. To stop the appliance oscillating, press it again. The appliance will not oscillate when the control buttons are pressed.

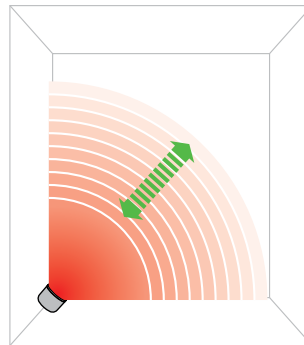

Airflow speed control
To change the airflow speed press the airflow control button. The digital display will show the new fan speed. If in heater mode after 2.5 seconds it will change back to displaying the target temperature.

Diffused and focused modes

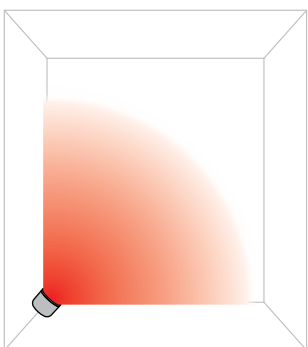

Diffused mode
Press the wide angle button to change from a personal directed airflow to a whole room airflow.

Heating and cooling modes work in this mode.

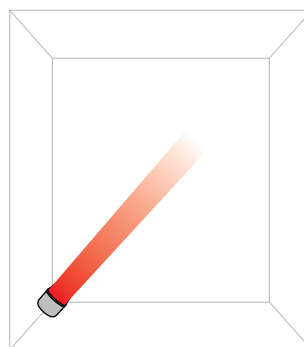

Focused mode
Press the narrow angle button to change from a whole room airflow to a personal directed airflow.

Heating and cooling modes work in this mode.

Sleep timer



The sleep timer will turn your appliance off once the time set has passed.

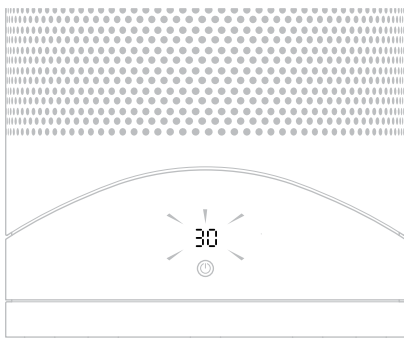

To set the sleep timer, select the desired time. When time reaches zero, the appliance will go into standby mode. To cancel, increase the time until two dashes appear.

Tilt function

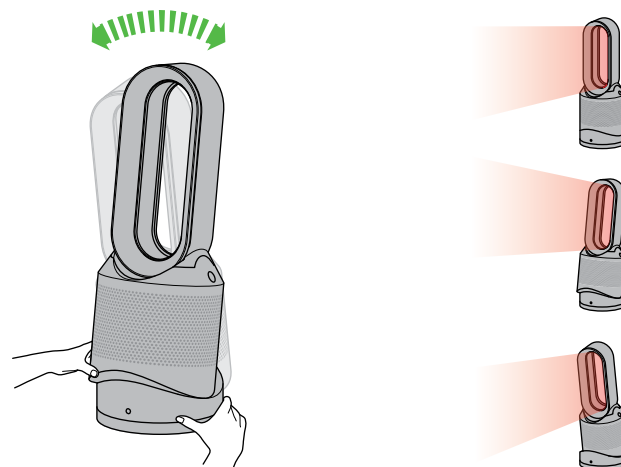

Carefully hold the base and the main body. Tilt the amplifier forward or backward for the required airflow angle.

Clearing blockages

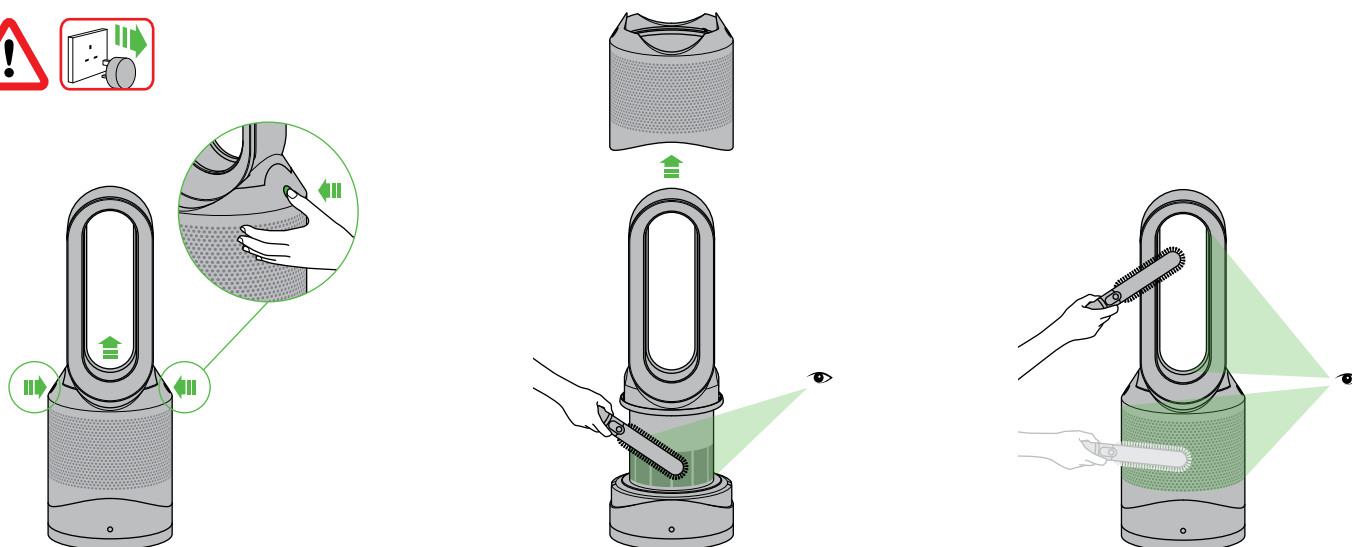
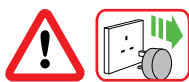

Ensure the appliance is unplugged. If the appliance has been in use, leave for 1 to 2 hours in order to allow the appliance to cool down completely. Look for blockages in the air inlet holes and in the small aperture inside the air loop amplifier. Use a soft brush to remove debris.

Cleaning

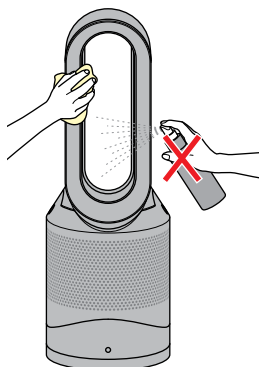

Unplug from the mains electricity supply. If the appliance has been in use, leave for 1 to 2 hours before cleaning to allow the appliance to cool completely. Dust may accumulate on the surface of the machine. Wipe dust from the loop, filter unit and other parts with a dry or damp cloth when dust accumulates. Do not use detergents or polishes

CAUTION: hot when in use

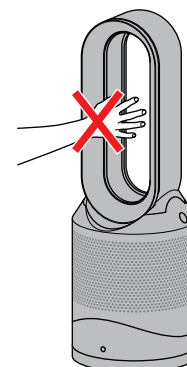

This appliance is hot when in use and for a short period after use. Do not let bare skin touch hot surfaces. If children are present, consider positioning the appliance out of their reach.



When your non-washable filter unit needs replacing the appliance will display the pattern shown. To replace the non-washable filter unit, follow these steps. If the appliance has been in use, leave for 1 to 2 hours before replacing the filter unit to allow the appliance to cool down completely. Your Dyson appliance is programmed to remind you to replace the filter unit after 12 months based on 12 hours usage a day. Please note your indicator will activate sooner with more use. The indicator is only a guide and you may need to replace the filter unit more regularly.

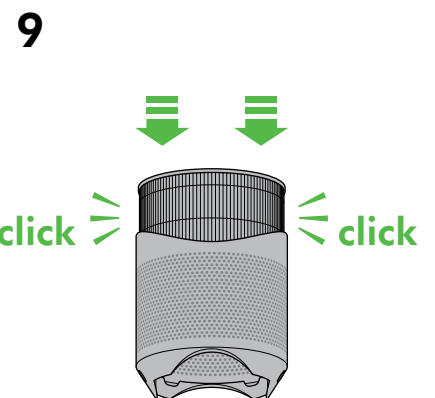
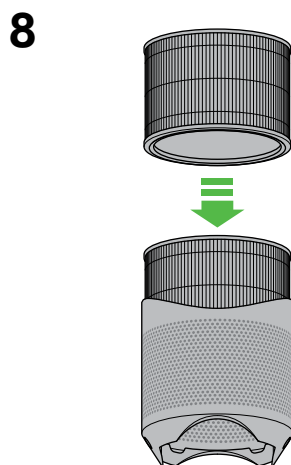
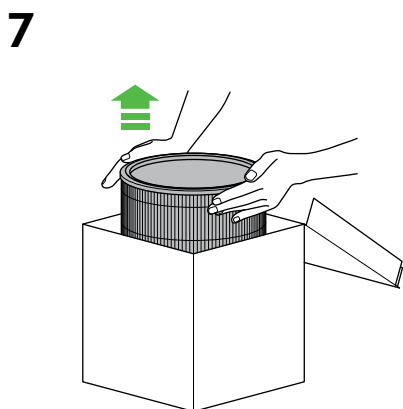
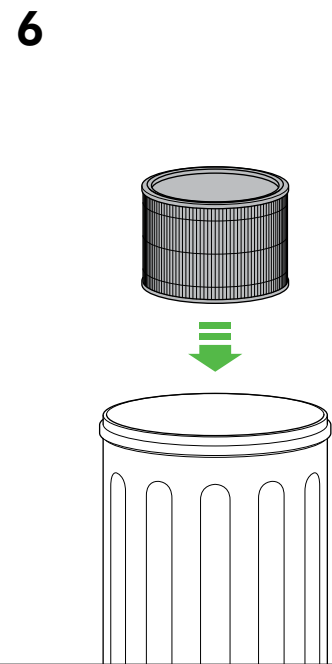
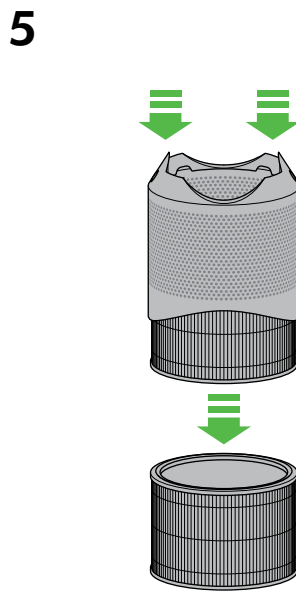
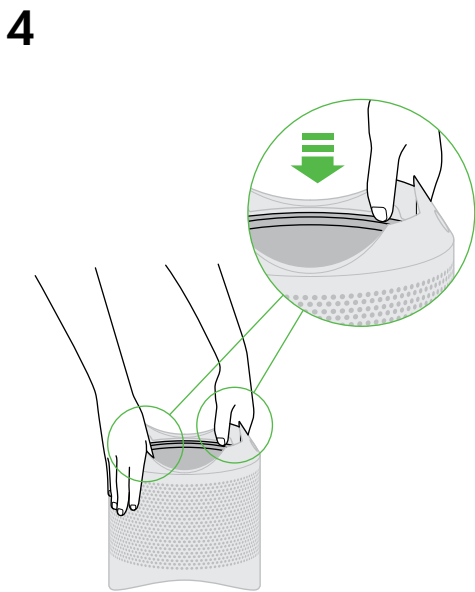
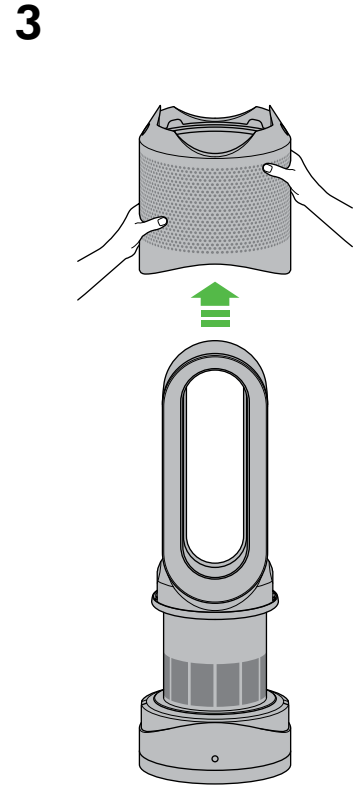
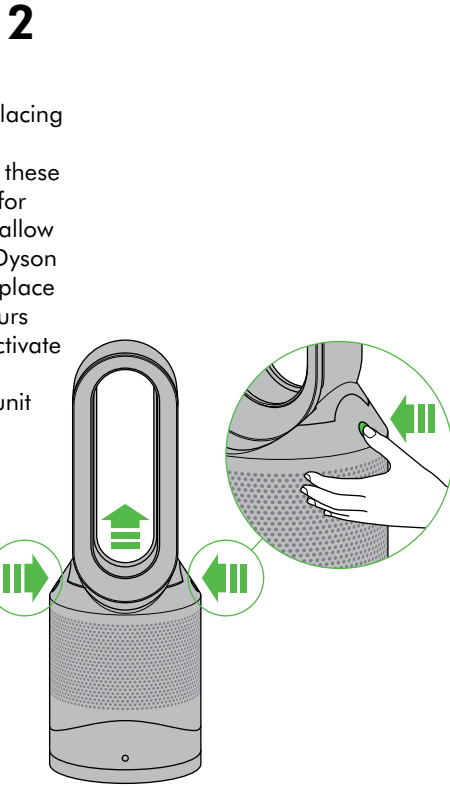
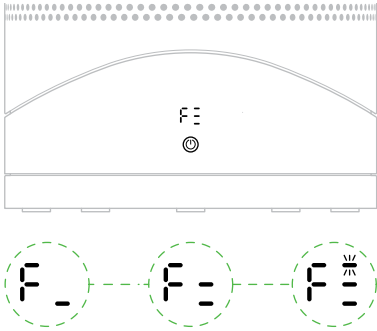

10

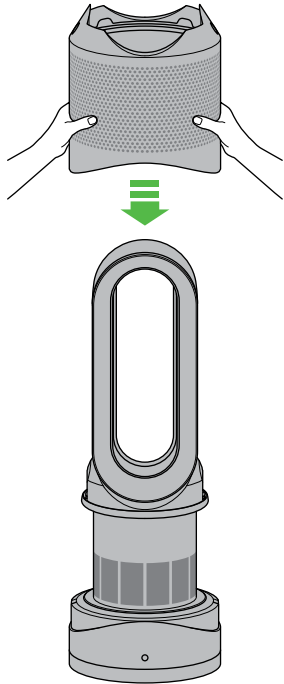

11

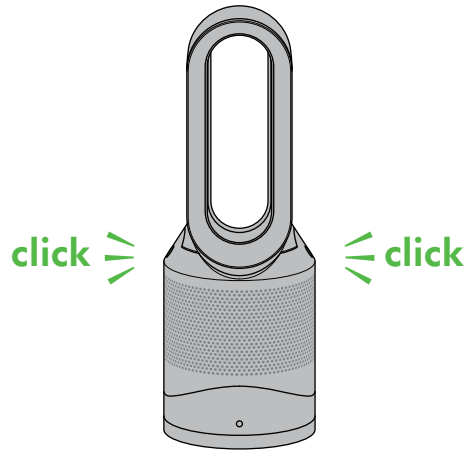

12

Clean the hatch every time the filter is replaced. Open the small hatch on the side of the appliance. Use a cotton bud to clean inside and remove any debris. This maintains sensor accuracy and ensures the continuing high performance of the appliance.

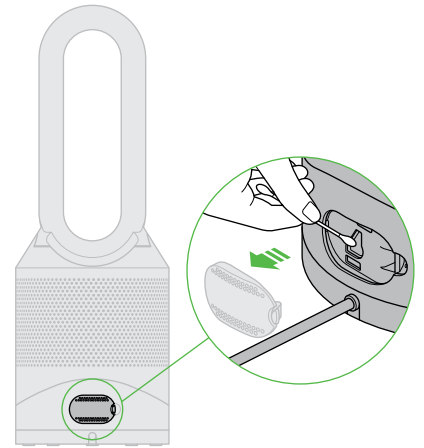

13

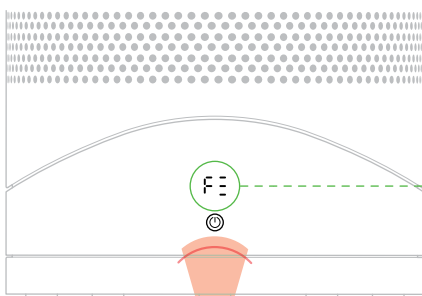
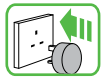

A clockwise-rotating loading pattern will be shown on the LED display.



Once the loading pattern is complete, the appliance will return to its normal usage.

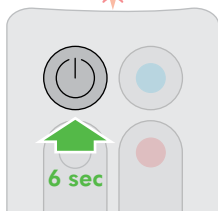
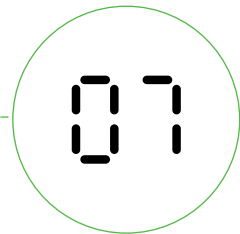

When you have re-assembled your appliance, press and hold the 'Standby ON/OFF' button for 6 seconds on the remote control to reset the filter indicator.



The Dyson Link app will notify you when your non-washable filter needs to be replaced. The filter indicator can also be reset from within the Dyson Link app.

Enabling or Disabling Wi-Fi



10-20 secs

Wi-Fi can be enabled or disabled by pressing and holding the ON/ OFF button on the appliance for between 10 and 20 seconds.

Wi-Fi disabled



Wi-Fi enabled

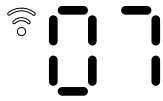

Solid white = Wi-Fi connected



Flashing white = Wi-Fi connecting



Flashing green = Wi-Fi is ready to connect to your Dyson Link app

Off = Wi-Fi disabled



If Wi-Fi is disabled, the appliance will not connect to the Dyson Link app.

Clearing your Wi-Fi settings



21 secs

It is possible to remove your network details from the appliance.



Press and hold the ON/ OFF button on the appliance for longer than 20 seconds.

The Wi-Fi symbol will flash alternately between white and green to indicate that your network details have been removed.



If you clear your network settings the appliance will not connect to the Dyson Link app.

Troubleshooting

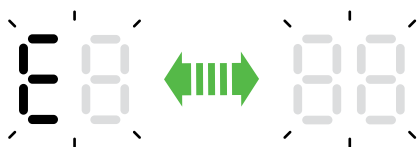

If you see a flashing 'E' when trying to use the appliance, it is unable to do what has been requested.



If you see a solid 'E' when trying to use the appliance, it shows the appliance has stopped functioning correctly.

Make sure you have checked the following:

- The room temperature is above 5°C.
- There are no blockages in the inlet grille or loop amplifier outlet.
- The filter has been correctly assembled and doesn't need to be replaced.
- The appliance is correctly plugged in directly to the wall outlet.

If the message still displays, unplug and leave for 10 seconds before turning on again. If the problem persists, please call the Dyson Helpline.

USING YOUR DYSON APPLIANCE

PLEASE READ THE 'IMPORTANT SAFETY INSTRUCTIONS' IN THIS DYSON OPERATING MANUAL BEFORE PROCEEDING.

LOOKING AFTER YOUR DYSON APPLIANCE

- Do not carry out any maintenance or repair work other than that shown in this Dyson Operating Manual, or advised by the Dyson Helpline.
- Always disconnect the plug from the mains before inspecting for problems. If the appliance will not operate, first check the mains socket has electricity supply and that the plug is properly inserted into the socket.

OPERATION

- Ensure appliance is fully assembled in line with the instructions before use. Do not dismantle the appliance or use without the loop amplifier fitted.
- The appliance will not operate in heating mode unless the target temperature is above the room temperature.
- Each time the heating mode is selected, it conducts a short calibration cycle. Airflow will be automatically controlled during this cycle. Once the calibration cycle is complete, it will revert to the selected airflow speed.
- The appliance will not oscillate when the control buttons are pressed.
- Do not lubricate any part of this appliance.

AUTO MODE

- A period of 6 days is required after the machine is first used for the sensor to calibrate. During this period the machine may be more sensitive to VOCs (such as odours) than normal.

CONTROL WITHOUT THE REMOTE

- The appliance can be controlled through your Dyson Link app.

DYSON LINK APP CONNECTIVITY

- You must have a live Internet connection in order for the Dyson Link app to work.
- The appliance only connects to 2.4GHz networks, which includes most modern routers. Check your router documentation for compatibility.
 - Wi-Fi 2.4-2.5 GHz, 0.08 W max
 - Supported Wi-Fi protocols: IEEE802.11b (Not recommended) IEEE802.11g IEEE802.11n (Support only for 2.4GHz) – Networked standby: 2.3 W

TILT FUNCTION

- Carefully hold the base and the main body. Tilt the amplifier forward or backward for the required airflow angle.

AUTOMATIC CUT-OUT

- For your safety this appliance is fitted with automatic cut-out switches that operate if the appliance tips over or overheats. If the switches operate, unplug the appliance and allow it to cool. Before restarting the appliance check and clear any blockages and ensure the appliance is on a solid level surface.
- In heating mode the appliance will automatically switch 'OFF' after 9 hours of continuous use and will return to standby mode. To restart the machine, press the power button on either the remote control or the base, or restart via the Dyson Link app.

REPLACEABLE PARTS

BATTERY REPLACEMENT

CAUTION

- Unscrew the battery compartment on the remote control. Loosen the base and pull to remove the battery.
- Do not install backwards or short circuit the batteries.
- Do not attempt to dismantle or charge the batteries. Keep away from fire.
- Always replace the screw in the remote control.
- Follow battery manufacturers' instructions when installing new batteries (battery type CR 2032).

NON-WASHABLE FILTER UNIT

- Your filter unit is non-washable and non-recyclable.
- To replace your filter unit follow the steps as shown.
- To dispose of your old filter unit: remove it from the appliance and place it in your household waste bin.
- A new filter unit can be purchased at www.dyson.com/filter.

DISPOSAL INFORMATION

- Dyson products are made from high grade recyclable materials. Recycle where possible.
- Dispose of or recycle the battery in accordance with local ordinances or regulations.
- This marking indicates that this product should not be disposed with other household wastes throughout the EU. To prevent possible harm to the environment or human health from uncontrolled waste disposal, recycle it responsibly to promote the sustainable reuse of material resources. To return your used device, please use the return and collection systems or contact the retailer where the product was purchased. They can take this product for environmentally safe recycling.
- Keep the used batteries away from children as these can still harm children if swallowed.
- Your filter unit is non-washable and non-recyclable.
- The battery should be removed from the product before disposal.

DYSON CUSTOMER CARE

THANK YOU FOR CHOOSING TO BUY A DYSON APPLIANCE

After registering your free 2 year guarantee, your Dyson appliance will be covered for parts and labour for 2 years from the date of purchase, subject to the terms of the guarantee. If you have any questions about your Dyson appliance, call the Dyson Helpline with your serial number and details of where/when you bought the appliance.

Most questions can be solved over the phone by one of our trained Dyson Helpline staff.

Visit www.dyson.co.uk/support (UK) or www.dyson.ie/support (ROI) for online help, support videos, general tips and useful information about Dyson.

Your serial number can be found on your rating plate which is on the base of the appliance.

If your Dyson appliance needs a service, call the Dyson Helpline so we can discuss the available options. If your Dyson appliance is under guarantee, and the repair is covered, it will be repaired at no cost.

PLEASE REGISTER AS A DYSON APPLIANCE OWNER

To help us ensure you receive prompt and efficient service, please register as a Dyson appliance owner. There are four ways to do this:

- Online at www.dyson.co.uk/register (UK) or www.dyson.ie/register (ROI).
- Telephone the Dyson Helpline on 0800 298 0298 (UK) or 01 475 7109 (ROI).
- Complete the enclosed form and post it to us.
- Smartphone. Download the Dyson Link app and you will be taken through registration as part of the set up. This will confirm ownership of your Dyson appliance in the event of an insurance loss, and enable us to contact you if necessary.

LIMITED 2 YEAR GUARANTEE

TERMS AND CONDITIONS OF THE DYSON 2 YEAR LIMITED GUARANTEE

WHAT IS COVERED

- The repair or replacement of your Dyson appliance (at Dyson's discretion) if it is found to be defective due to faulty materials, workmanship or function within 2 years of purchase or delivery (if any part is no longer available or out of manufacture Dyson will replace it with a functional replacement part).
- Where this machine is sold outside of the EU, this warranty will only be valid if the appliance is used in the country in which it was sold.
- Where this machine is sold within the EU, this warranty will only be valid (i) if the appliance is used in the country in which it was sold or (ii) if the appliance is used in Austria, Belgium, France, Germany, Ireland, Italy, Netherlands, Spain or the United Kingdom and the same model as this appliance is sold at the same voltage rating in the relevant country.

WHAT IS NOT COVERED

- Replacement filters. The machine's filter is not covered by the guarantee. Dyson does not guarantee the repair or replacement of a product where a defect is the result of:
 - Damage caused by not carrying out the recommended appliance maintenance.
 - Accidental damage, faults caused by negligent use or care, misuse, neglect, carelessness or operation or handling of the appliance which is not in accordance with the Dyson Operating Manual.
 - Use of the appliance for anything other than normal domestic household purposes.
 - Use of parts not assembled or installed in accordance with the instructions of Dyson.
 - Use of parts and accessories which are not genuine Dyson components.
 - Faulty installation (except where installed by Dyson).
 - Repairs or alterations carried out by parties other than Dyson or its authorised agents.
 - Blockages – please refer to the Dyson Operating Manual for details of how to look for and clear blockages.
 - Normal wear and tear (e.g. fuse etc.).
 - Reduction in battery discharge time due to battery age or use (where applicable).
- If you are in any doubt as to what is covered by your guarantee, please contact the Dyson Helpline.

SUMMARY OF COVER

- The guarantee becomes effective at the date of purchase (or the date of delivery if this is later).
- You must provide proof of (both the original and any subsequent) delivery/purchase before any work can be carried out on your Dyson appliance. Without this proof, any work carried out will be chargeable. Keep your receipt or delivery note.
- All work will be carried out by Dyson or its authorised agents.
- Any parts which are replaced by Dyson will become the property of Dyson.
- The repair or replacement of your Dyson appliance under guarantee will not extend the period of guarantee.
- The guarantee provides benefits which are additional to and do not affect your statutory rights as a consumer.

PRIVACY AND PERSONAL DATA PROTECTION

You will need to provide us with basic contact information when you register your Dyson Product or the Dyson Link App;

WHEN REGISTERING YOUR DYSON PRODUCT

- You will need to provide us with basic contact information to register your product and enable us to support your guarantee.

WHEN REGISTERING VIA THE DYSON LINK APP

You will need to provide us with basic contact information to register the Dyson Link App; this enables us to securely link your product to your instance of the App.

- When you register, you will have the opportunity to choose whether you would like to receive communications from us. If you opt-in to communications from Dyson, we will send you details of special offers and news of our latest innovations. We never sell your information to third parties and only use information that you share with us as defined by our privacy policies which are available on our website. www.dyson.co.uk/support/privacypolicy

Serial number

Large empty box for serial number entry.

Date of purchase

Grid for date of purchase (DD/MM/YY).

Country of purchase

Country selection checkboxes for UK and ROI.

Title

Surname

Grid for title and surname.

First name

Grid for first name.

Address

Large grid for address entry.

Postcode

Grid for postcode.

e-mail

Grid for email address.

Telephone

Grid for telephone number.

Mobile

Grid for mobile number.

As a Dyson purifier owner, you can hear about Dyson inventions, services and products before anyone else. If it's okay to contact you, please let us know how we may do this.

Form with checkboxes for contact preferences: By mail, By phone, By email, By text message.

We sometimes ask other companies (such as market researchers) to contact owners on our behalf. We do this to get feedback on ideas or ask you to try new products and services. Would this be okay?

Form with checkboxes for market research consent: Yes, No.



REGISTER WITH YOUR SMARTPHONE

Download the Dyson Link app and you will be taken through registration as part of the set up.



REGISTER ONLINE

Visit our website to register your full parts and labour guarantee online. www.dyson.co.uk/register www.dyson.ie/register



REGISTER BY PHONE

Call our dedicated Helpline. Open Monday to Friday 8am-8pm & Saturday and Sunday 8am-6pm. UK: 0800 298 0298 ROI: 01 475 7109

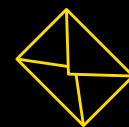

REGISTER BY MAIL

Complete and return the form to Dyson in the envelope supplied.

